

Cross roller bearings

RA-RA 10008

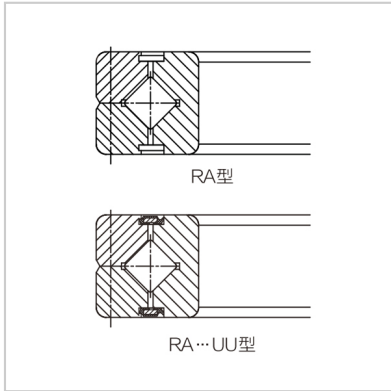
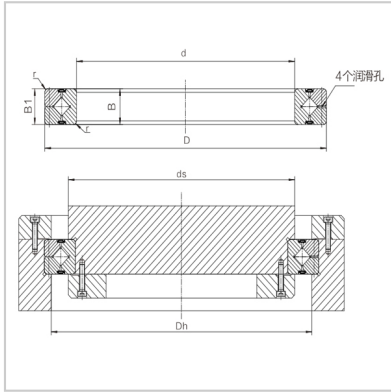

Nominal model : RA 10008

Main dimensions (mm) :

d : 100

D : 116

B : 8

Roller pitch diameter
 Dpw : 107

Chamfered r min : 0.5

Shoulder size (mm) :

ds : 103.5

Dh : 110.5

Basic rated load (radial) :

C_r kN : 7.15

C_{0r} kN : 13.9

Weight :

K_g : 0.14

: