

Cross roller bearings

RA-RA9008

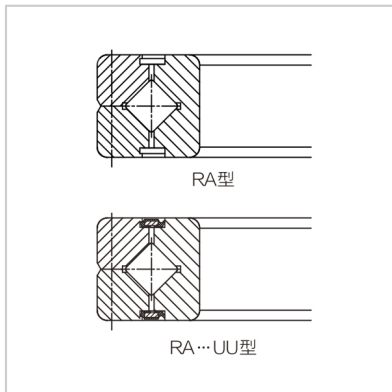
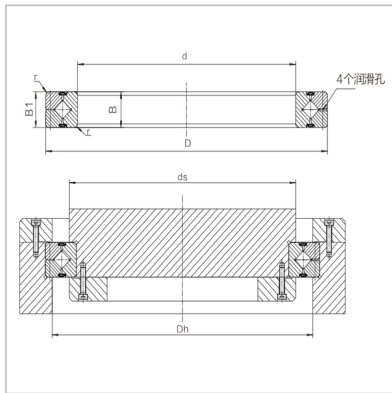

Nominal model : RA9008

Main dimensions (mm) :

d : 90

D : 106

B : 8

Roller pitch diameter
 Dpw : 97

Chamfered r min : 0.5

Shoulder size (mm) :

ds : 93.5

Dh : 100.5

Basic rated load (radial) :

C_r kN : 6.76

C_{0r} kN : 12.4

Weight :

K_g : 0.12

: