

Cross roller bearings

RA-RA19013

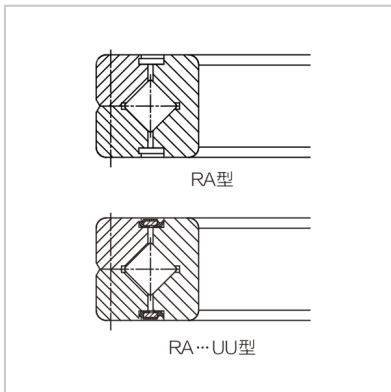
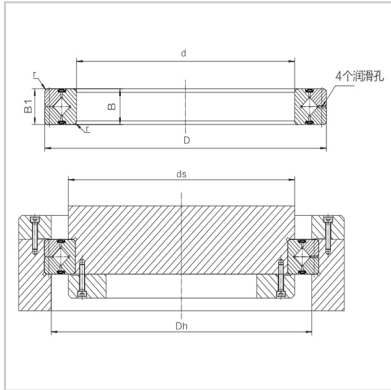

Nominal model : RA19013

Main dimensions (mm) :

d : 190

D : 216

B : 13

Roller pitch diameter
Dpw : 202

Chamfered r min : 0.8

Shoulder size (mm) :

ds : 195

Dh : 209

Basic rated load (radial) :

Cr kN : 24.9

C0r kN : 51.5

Weight :

Kg : 0.69

: