

Cross roller bearings

RA-RA17013

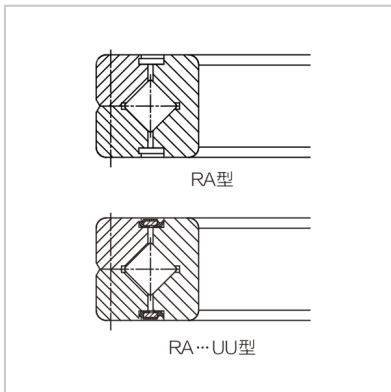
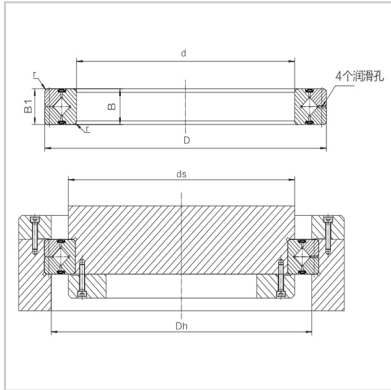

Nominal model : RA17013

Main dimensions (mm) :

d :	170
D :	196
B :	13
Roller pitch diameter Dpw :	182
Chamfered r min :	0.8

Shoulder size (mm) :

ds :	175
Dh :	189

Basic rated load (radial) :

Cr kN :	23.5
C0r kN :	46.5

Weight :

Kg :	0.64
------	------

: