

Ball screw

BBFS-BBFS2506-2

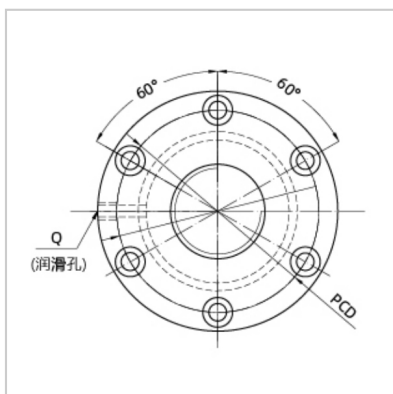
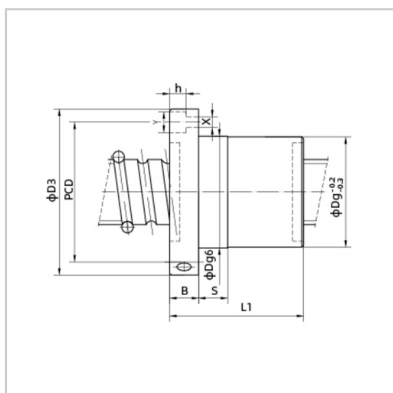

Nominal model :	BBFS2506-2
Screw size :	
Outer diameter of lead screw :	25
Bottom diameter of rolling track :	22
Lead the way :	6
Steel ball size :	3.969
Number of cycles :	2
Rated load (kgf) :	
Dynamic load :	1142
Static load :	1968
Nut :	
Dg6 :	40
L1 :	65
Flange :	
D3 :	66
B :	11
PCD :	53
Coordination :	
S :	10
Oil hole :	
Q :	M6X1P
Screw hole :	
X :	5.8
Y :	10
h :	6
Rigidity :	
kgf/μm :	35

:

