

Ball screw

BBFS-BBFS2005-2

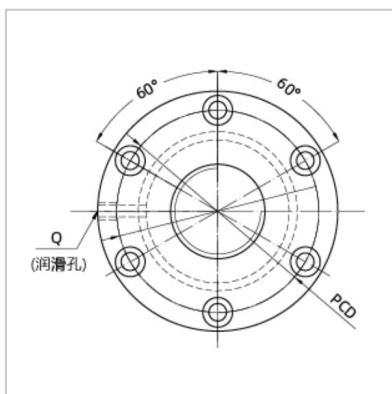
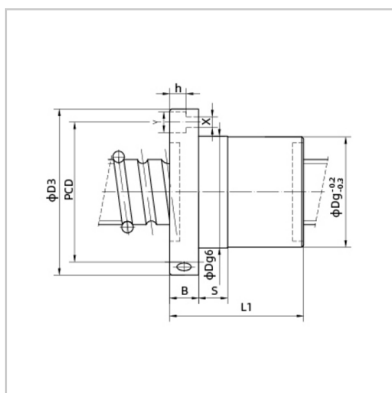

Nominal model :	BBFS2005-2
Screw size :	
Outer diameter of lead screw :	20
Bottom diameter of rolling track :	17.4
Lead the way :	5
Steel ball size :	3.5
Number of cycles :	2
Rated load (kgf) :	
Dynamic load :	856
Static load :	1346
Nut :	
Dg6 :	36
L1 :	55
Flange :	
D3 :	62
B :	11
PCD :	48
Coordination :	
S :	10
Oil hole :	
Q :	M6X1P
Screw hole :	
X :	5.8
Y :	10
h :	6
Rigidity :	
kgf/μm :	28

:

