

Ball screw

BBFS-BBFS4006-2

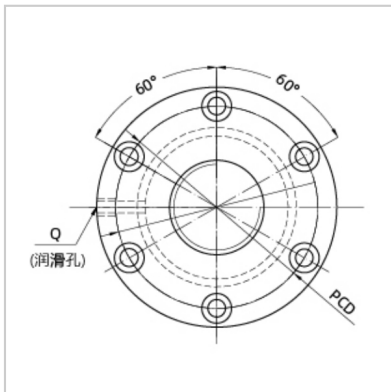
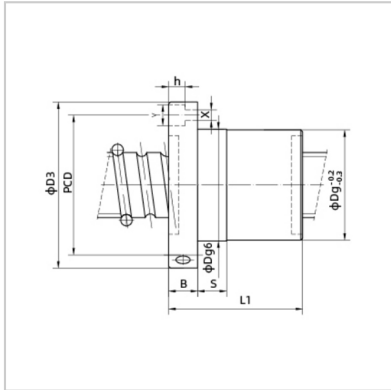

Nominal model :	BBFS4006-2
Screw size :	
Outer diameter of lead screw :	40
Bottom diameter of rolling track :	37
Lead the way :	6
Steel ball size :	3.969
Number of cycles :	2
Rated load (kgf) :	
Dynamic load :	1447
Static load :	3344
Nut :	
Dg6 :	60
L1 :	68
Flange :	
D3 :	94
B :	15
PCD :	75
Coordination :	
S :	10
Oil hole :	
Q :	M6X1P
Screw hole :	
X :	9
Y :	15
h :	9
Rigidity :	
kgf/μm :	52

:

