

Ball screw

BBFS-BBFS2004-3

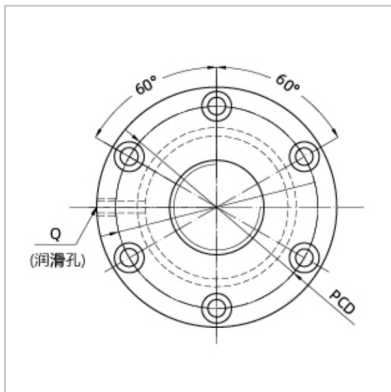
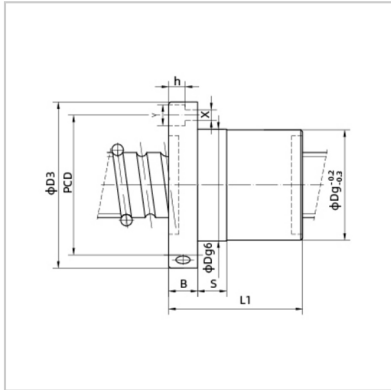

Nominal model :	BBFS2004-3
-----------------	------------

Screw size :

Outer diameter of lead screw :	20
Bottom diameter of rolling track :	17.8
Lead the way :	4
Steel ball size :	3
Number of cycles :	3

Rated load (kgf) :

Dynamic load :	978
Static load :	1682

Nut :

Dg6 :	36
L1 :	59

Flange :

D3 :	62
B :	11
PCD :	48

Coordination :

S :	10
-----	----

Oil hole :

Q :	M6X1P
-----	-------

Screw hole :

X :	5.8
Y :	10
h :	6

Rigidity :

kgf/μm :	40
----------	----

:

