

Ball screw

BBFS-BBFS4005-2

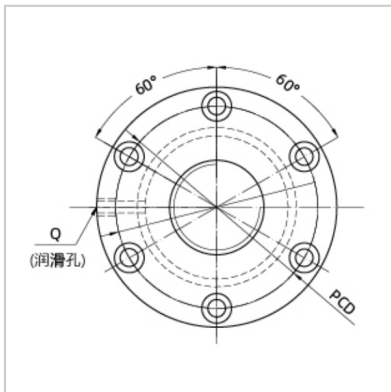
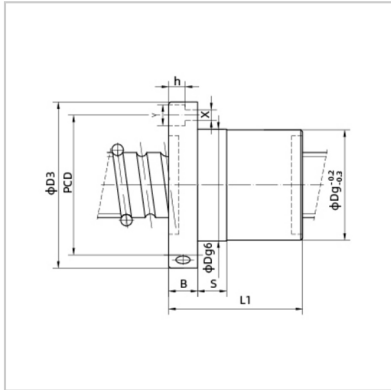

Nominal model :	BBFS4005-2
Screw size :	
Outer diameter of lead screw :	40
Bottom diameter of rolling track :	37.4
Lead the way :	5
Steel ball size :	3.5
Number of cycles :	2
Rated load (kgf) :	
Dynamic load :	2967
Static load :	2967
Nut :	
Dg6 :	60
L1 :	58
Flange :	
D3 :	94
B :	15
PCD :	75
Coordination :	
S :	10
Oil hole :	
Q :	M6X1P
Screw hole :	
X :	9
Y :	15
h :	9
Rigidity :	
kgf/μm :	51

:

