

Ball screw

BBFS-BBFS3205-3

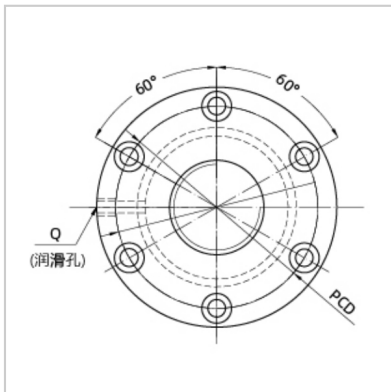
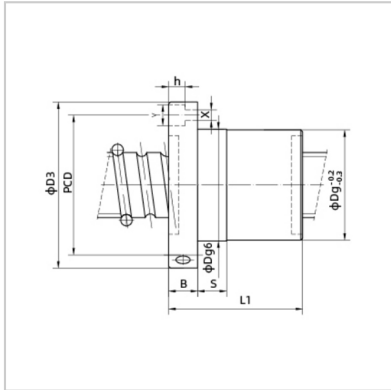

Nominal model :	BBFS3205-3
Screw size :	
Outer diameter of lead screw :	32
Bottom diameter of rolling track :	29.4
Lead the way :	5
Steel ball size :	3.5
Number of cycles :	3
Rated load (kgf) :	
Dynamic load :	1560
Static load :	3497
Nut :	
Dg6 :	50
L1 :	71
Flange :	
D3 :	82
B :	13
PCD :	67
Coordination :	
S :	10
Oil hole :	
Q :	M6X1P
Screw hole :	
X :	7
Y :	12
h :	7
Rigidity :	
kgf/μm :	64

:

