

Ball screw

BDFD-BDFD4010-5

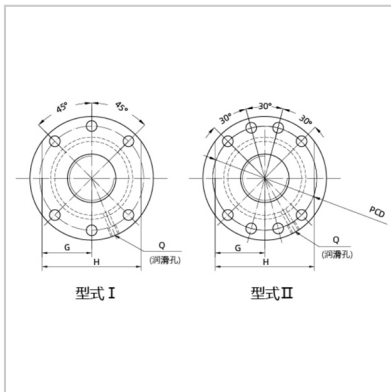
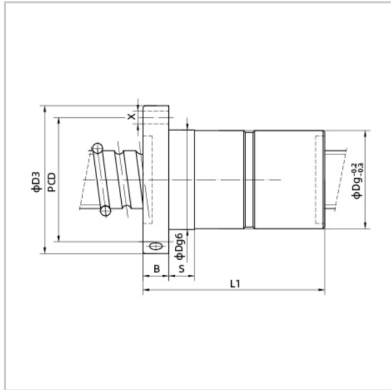

Nominal model :	BDFD4010-5
Screw size :	
Outer diameter of lead screw :	32
Bottom diameter of rolling track :	26.9
Lead the way :	10
Steel ball size :	6.35
Number of cycles :	5
Rated load (kgf) :	
Dynamic load :	6006
Static load :	13256
Nut :	
Dg6 :	70
L1 :	169
Flange :	
D3 :	100
B :	14
PCD :	85
G :	37.5
H :	75
Type :	
Coordination :	
S :	20
Oil hole :	
Q :	M8X1P
Screw hole :	
X :	9
Rigidity :	
kgf/μm :	138

: