

Ball screw

BDFD-BDFD3216-4

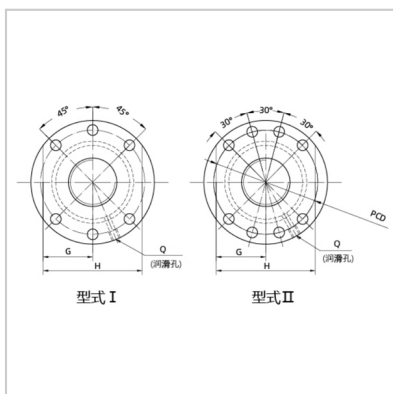
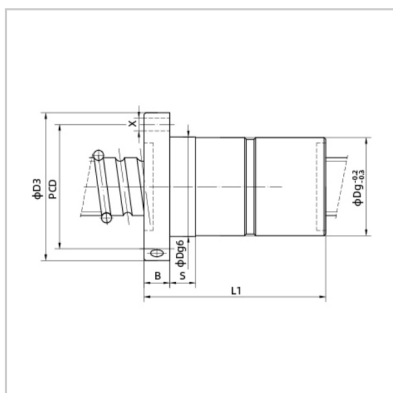

Nominal model :	BDFD3216-4
Screw size :	
Outer diameter of lead screw :	32
Bottom diameter of rolling track :	26.9
Lead the way :	16
Steel ball size :	6.35
Number of cycles :	4
Rated load (kgf) :	
Dynamic load :	4313
Static load :	8178
Nut :	
Dg6 :	62
L1 :	189
Flange :	
D3 :	92
B :	14
PCD :	77
G :	37
H :	74
Type :	I
Coordination :	
S :	20
Oil hole :	
Q :	M8X1P
Screw hole :	
X :	9
Rigidity :	
kgf/ μ m :	91

: