

Ball screw

BDFD-BDFD5016-5

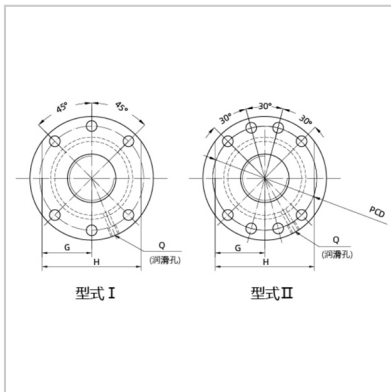
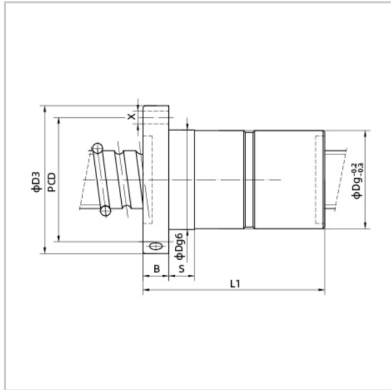

Nominal model :	BDFD5016-5
Screw size :	
Outer diameter of lead screw :	50
Bottom diameter of rolling track :	44.9
Lead the way :	16
Steel ball size :	6.35
Number of cycles :	5
Rated load (kgf) :	
Dynamic load :	6648
Static load :	16723
Nut :	
Dg6 :	82
L1 :	219
Flange :	
D3 :	118
B :	16
PCD :	100
G :	46
H :	92
Type :	
Coordination :	
S :	20
Oil hole :	
Q :	M8X1P
Screw hole :	
X :	11
Rigidity :	
kgf/μm :	167

: