

Ball screw

**BDFD-BDFD4030-3**

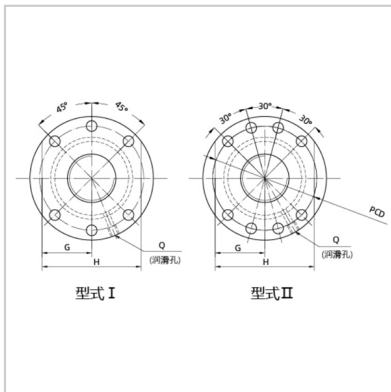
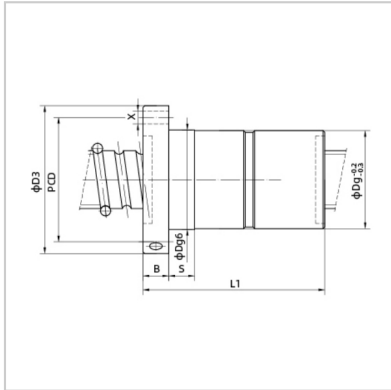

Nominal model :	BDFD4030-3
Screw size :	
Outer diameter of lead screw :	40
Bottom diameter of rolling track :	34.9
Lead the way :	30
Steel ball size :	6.35
Number of cycles :	3
Rated load (kgf) :	
Dynamic load :	3752
Static load :	7862
Nut :	
Dg6 :	70
L1 :	239
Flange :	
D3 :	100
B :	14
PCD :	85
G :	37.5
H :	75
Type :	
Coordination :	
S :	20
Oil hole :	
Q :	M8X1P
Screw hole :	
X :	9
Rigidity :	
kgf/ $\mu$ m :	83

: